

# TWO WAY MANIFOLD VALVE SSKE35-2

## APPLICATIONS

- Isolation for pressure instruments and Pressure Line
- Liquid and Gas applications
- Corrosive media

## FEATURES

- Suitable for High Pressure line
- Isolation & Vent Valve with Rigid Construction
- Drainage port

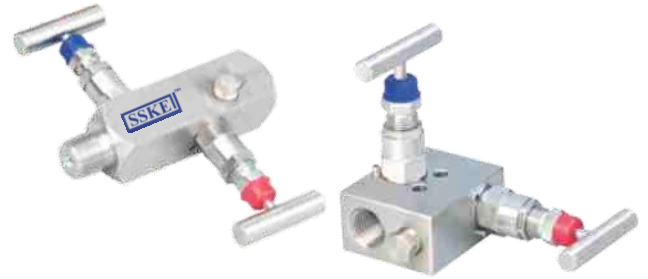

TWO WAY MANIFOLD VALVE , SSKE35-2

## DESCRIPTION

### General

Thread design : ANSI B1.20.1 / BS EN ISO 228-1

Storage temperature : -40...+65°C

Service temperature : 240°C max.

Working Pressure : 6000 psi max.

### Material of construction

Body material : AISI 304 SS / AISI 316 SS / AISI 316LSS / Monel

Packing Material : PTFE / Grafoil

### Standard version

Steam Type : Hard Seated stem

Wetted Parts: AISI 316 SS

Stem Packing : PTFE

Stem Tip form: Conical Metal Tip

Instrument connection : 1/2" NPT (F) / 1/2" BSP (F)

Process connection : 1/2" NPT (M) / 1/2" BSP (M)

Drainage Plug: 1/4" NPT (M)

## GA DRAWING

RM.MV-1

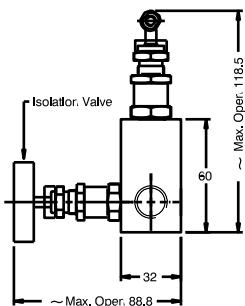
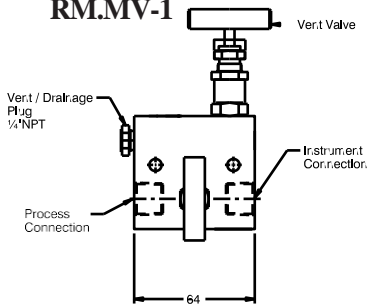

RM.MV-2

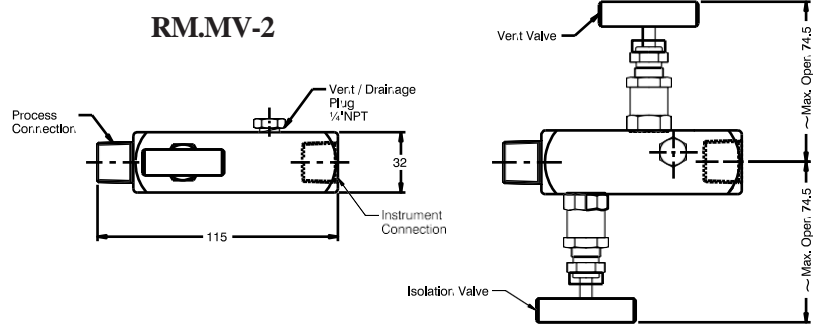

RM.MV-3

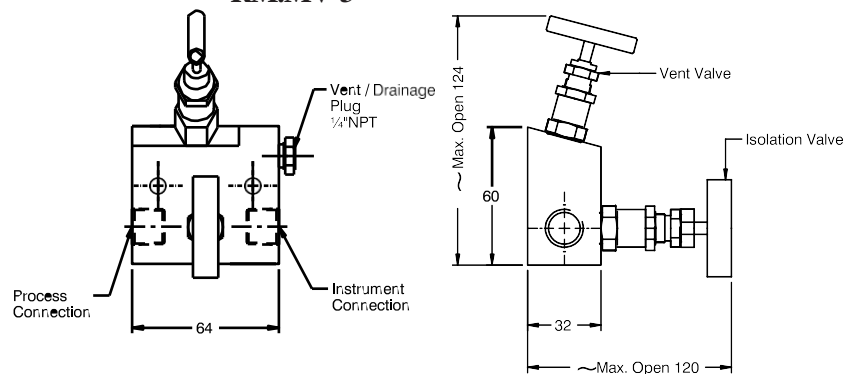

RM.MV-5

Remote mount - Pattern 5

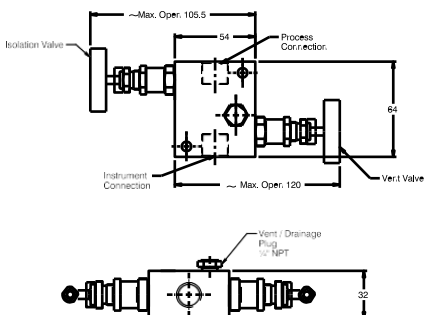

RM.MV-4

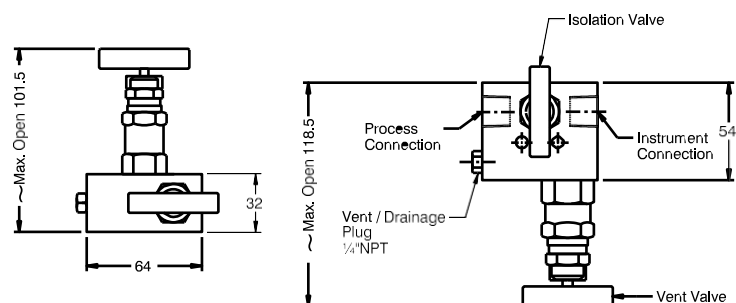

# TWO WAY MANIFOLD VALVE

## SSKE35-2

### ORDERING CODES

MODEL SSKE35-2 -TWO WAY MANIFOLD VALVE , RM.MV-1/ RM.MV-2/RM.MV3/RM.MV-4/RM.MV-5

SSKE35-2  
RM.MV-1

#### STEM TYPE

HSM

**HSM** Hard seated stem (Metal)      **SSD** Soft seated stem (Derlin)      **RPD** Rising plug stem (Derlin)

#### BODY/ WETTED MATERIAL

VS01

**VS01** AISI 304 SS      **VS02** AISI 316 SS      **VS03** AISI 316L SS      **VS05** MONEL      **VS10** HAST-C

#### INSTRUMENT CONNECTION- 3 PORTS -INSTR. CONN /DRAIN PORT / BLEED PORT

P27

**P28** ½" NPT(F)      **P24** ¼" NPT (F)      **P23** ¼" BSP (F)      **P27** ½" BSP (F)      **P04** ¼" NPT (M)      **P08** ½" NPT (M)  
**P03** ¼" BSP(M)      **P05** 3/8" BSP (M)      **P20** M20X1.5mm (M)      **P07** 1/2" BSP (M)

#### PROCESS CONNECTION

P07

**P28** ½" NPT (F)      **P24** ¼" NPT (F)      **P23** ¼" BSP (F) **P05**      **P27** ½" BSP (F)      **P04** ¼" NPT (M)      **P08** ½" NPT (M)  
**P03** ¼" BSP (M)      **P20** M20X1.5mm (M)      **P07** 1/2" BSP (M)

#### STEMPACKING

S11

**S11** PTFE      **S21** GRAFOIL

#### OPTIONS

E90

**E90** HYDRO TEST CERTIFICATE      **E31** Material test certificate 3.1      **E32** Material test certificate 2.2

Rev 00

© 2016 SSKE All rights reserved. The technical details & specifications are provided as such at the time of printing. Technical changes and omissions may happen later.